

Trapezoidal nut type MES – Hexagonal in steel

Material: EN 10277-3 11SMnPb37 – 1.0737

Fixing nut very convenient thanks to its hexagonal shape. Not suitable for operations with high loads, because the coupling steel-steel tends to seize. This nuts can be MIG welded only. Electrode welding is not recommended because of the lead.

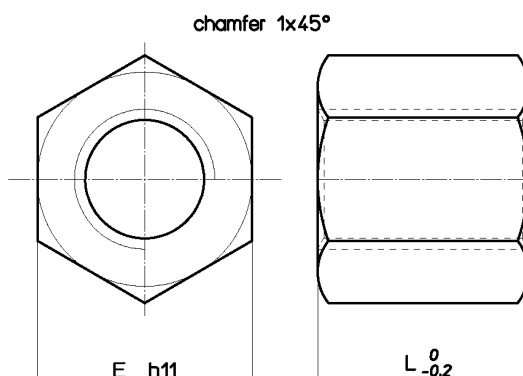

Nut Stock no. RIGHT	Nut Stock no. LEFT	Diameter x lead	Thread starts	E mm	L mm	Wt. kg/each	At mm ² (1)
MES 10 T R	MES 10 T L	Tr 10x2	1	17	15	0.023	212
MES 10 A R	MES 10 A L	Tr 10x3	1	17	15	0.021	200
MES 12 A R	MES 12 A L	Tr 12x3	1	19	18	0.027	296
MES 12 B R	--	Tr 12x6 (P3)	2	19	18	0.027	296
MES 14 R R	MES 14 R L	Tr 14x3	1	22	21	0.044	412
MES 14 A R	MES 14 A L	Tr 14x4	1	22	21	0.044	395
MES 14 B R	--	Tr 14x6 (P3)	2	22	21	0.044	412
MES 16 A R	MES 16 A L	Tr 16x4	1	27	24	0.082	528
MES 16 B R	--	Tr 16x8 (P4)	2	27	24	0.082	528
MES 18 A R	MES 18 A L	Tr 18x4	1	27	27	0.084	678
MES 20 A R	MES 20 A L	Tr 20x4	1	30	30	0.114	847
MES 20 B R	--	Tr 20x8 (P4)	2	30	30	0.114	847
MES 22 A R	MES 22 A L	Tr 22x5	1	30	33	0.112	1010
MES 24 A R	MES 24 A L	Tr 24x5	1	36	36	0.200	1215
MES 26 A R	MES 26 A L	Tr 26x5	1	36	39	0.193	1440
MES 28 A R	MES 28 A L	Tr 28x5	1	41	42	0.291	1680
MES 30 A R	MES 30 A L	Tr 30x6	1	46	45	0.420	1908
MES 30 B R	--	Tr 30x12 (P6)	2	46	45	0.420	1908
MES 32 A R	MES 32 A L	Tr 32x6	1	46	48	0.411	2186
MES 36 A R	MES 36 A L	Tr 36x6	1	55	54	0.706	2800
MES 40 A R	MES 40 A L	Tr 40x7	1	65	60	1.172	3440
MES 44 A R	MES 44 A L	Tr 44x7	1	65	66	1.159	4200
MES 50 A R	MES 50 A L	Tr 50x8	1	75	75	1.783	5418
MES 60 A R	MES 60 A L	Tr 60x9	1	90	90	3.087	7847
MES 70 A R	MES 70 A L	Tr 70x10	1	90	105	2.837	10720

(1) Total bearing surface between screw and nut teeth on plane perpendicular to axis.