

T3A132SB-2 7,5KW 400/690V B3

Three-phase asynchronous motor in aluminum

Motor type T3A132SB-2 7,5KW 400/690V B3
 Brand BUSCK
 Item number 93021331

Voltage V	Power kW	Frequency Hz	Current A	Speed rpm
400	7,5	50	13,35	2930
690	7,5	50	7,68	2930
460	8,63	60	13,35	3516

Duty	S1	Efficiency class	IE3
Enclosure	IP55	Efficiency, load 100%	90,1
Insulation class	F	Efficiency, load 75%	90,2
Cooling	IC411 (TEFC)	Efficiency, load 50%	89,1
Max. ambient temp.	40°C	Power fact, load 100%	0,90
Min. ambient temp.	-20°C	Painting	Standard
Max. temp. rise	80 K	Color	RAL 9005
Max altitude, masl	1000	Weight kg	51,7
Torque, Nm	24,45	Sound pressure Lp dB(A)	80
Starting torque ratio	3,6	Bearing DE	6308-2Z/C3
Pull up torque ratio	2,4	Bearing NDE	6208-2Z/C3
Pull out torque ratio	4,7	Balance grade	Normal
Starting current ratio	11,9	Inertia kgm ²	0,018996
Winding protection	Thermocontacts	Cable entries	2xM25, 1xM16

Note IE3, Termokontakter

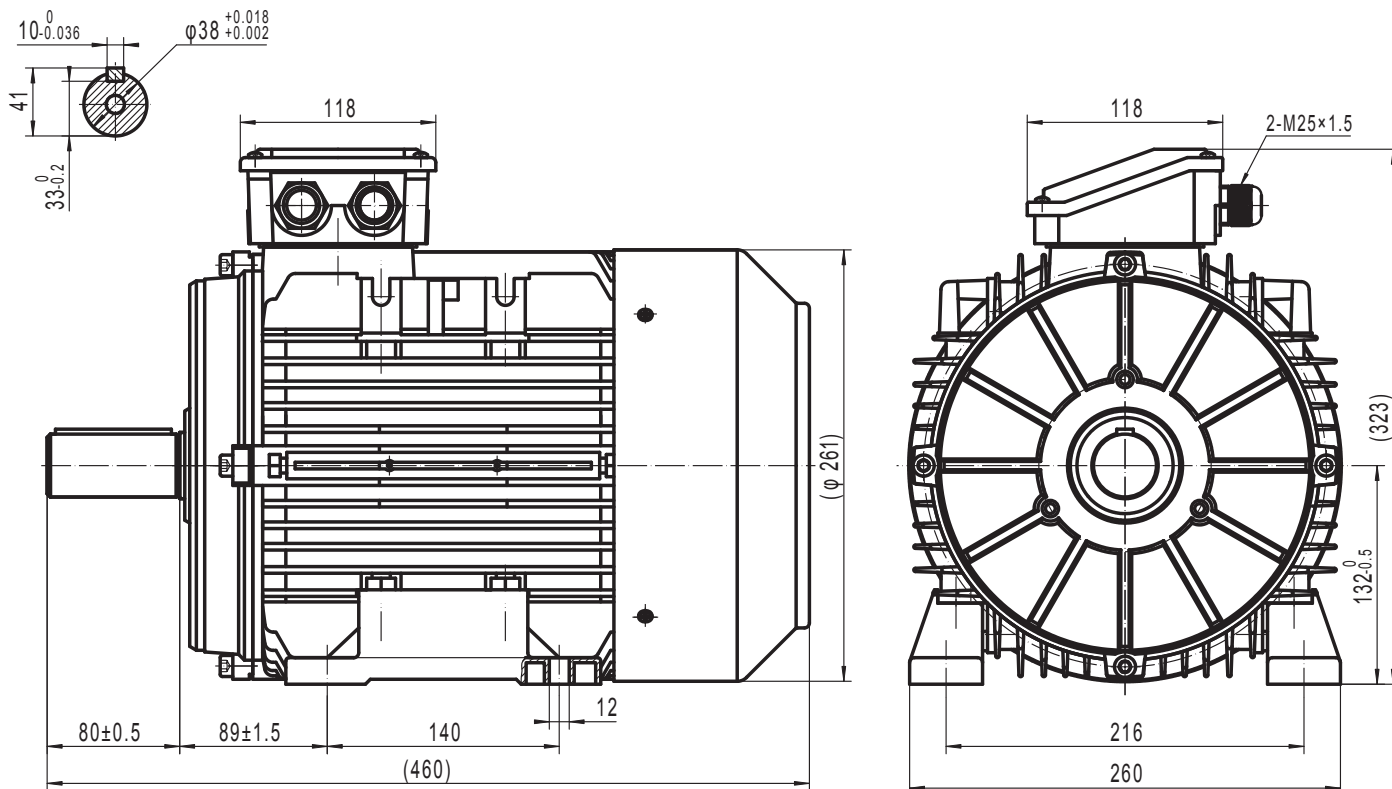

BUSCK
www.busck.eu

Busck & Co AB
 Gamla Riksvägen 14
 428 32 Göteborg
 Sweden
 556027-1990
info@busck.se

Busck & Co ApS
 Postboks 108
 0900 København C
 Denmark
info@busck.eu

Busck AS
 Skibåsen 35C
 4636 Kristiansand
 Norway
info@busck.no